

# NK Windows – Window & Door Designs

Version: 06 Date: August 2020

**NK Windows offer a wide range of window and door styles, designs and sizes. Things to consider when designing your windows and doors are: colour, style, size, functionality, accessibility and security.**

## Colours

Windows and doors are available in the base colours of White and Cream, plus over 45 laminated foil colours, which can be applied to either one side or both sides of the frame.

NK Windows carries the following window frame colours in stock in New Zealand:

- White
- Cream
- Golden Oak (interior & exterior). Colour Code: 23
- Anthracite Grey exterior/ White interior. Colour Code: 60

All other 40+ laminated colours are available ex-Germany. Please check with NK Windows for availability.

NK Windows also carries a number of entrance door colours in stock in New Zealand:

- White
- Cream
- Golden Oak (interior & exterior). Colour Code: 23
- Anthracite Grey exterior/ White interior. Colour Code: 60
- Anthracite Grey (interior & exterior). Colour Code: 60

- Red (interior & exterior). Colour Code: 32
- Mountain Pine (interior & exterior). Colour Code: 56

All other 40+ laminate colours are available ex-Germany. Please check with NK Windows for availability.

Additionally, it is possible to add an aluminium “skin” to the exterior surface of a range of windows and doors. This skin can be powder-coated in a wide range of standard colours available in New Zealand.

## Opening types

NK Windows specializes in the European-style tilt & turn inwards opening windows and doors. Tilt & turn windows provide superior security and sealing, secure street-level ventilation, easy high access cleaning and a very wide opening for emergency egress. NK Windows also offers (non-tilting!) outwards opening windows – both top-hung (awning) and side-hung (casement) style, plus many other options.

## Design

uPVC frames are very well suited to all home designs and can be installed regardless of construction and cladding type. A chunkier profile is often preferred when looking to replace wooden frames, as it preserves the look and style of the house. At the same time, most

# NK Windows – Window & Door Designs

Version: 06 Date: August 2020

homeowners will take the opportunity to modernize their home by simplifying openings (most older houses have way too many openings) and removing colonial bars etc. Windows and doors can easily be manufactured to replicate window styles from previous eras, including: cottage, villa, bungalow, state house, art deco, 1970's, 1980's and beyond.

**The line drawings on the following pages will hopefully provide some understanding and inspiration in terms of what is possible. This is by no means an exhaustive list of what we can do, so please let us know if you have something specific in mind.**

**The drawings are divided into the following sections:**

- 1. Fixed Windows**
- 2. Tilt & Turn Inwards Opening Windows**
- 3. Outwards Opening Windows**
- 4. Sliding windows and doors stacking / multi slider**
- 5. Bi-folding windows and doors**
- 6. Entrance doors**
- 7. Single and French doors**
- 8. Sliding doors – tilt & slide doors**
- 9. Sliding doors – Smart Slider doors**
- 10. Sliding doors – lift & slide doors**

## 1. Fixed Windows

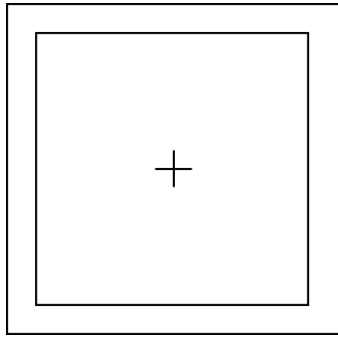

*Code 1.01: Rectangle*

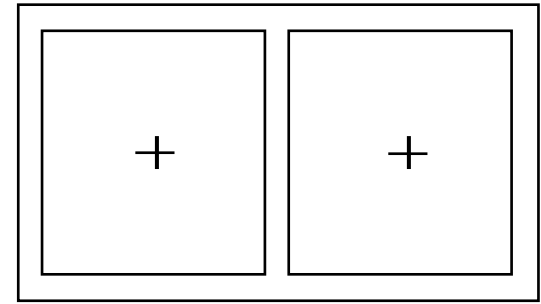

*Code 1.02: Rectangle with Mullion (s)*

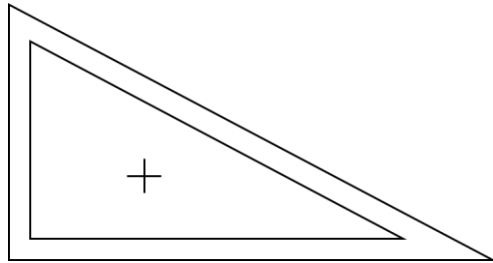

*Code 1.03: Raked*

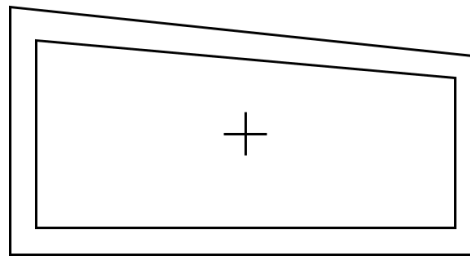

*Code 1.04: Trapezoidal*

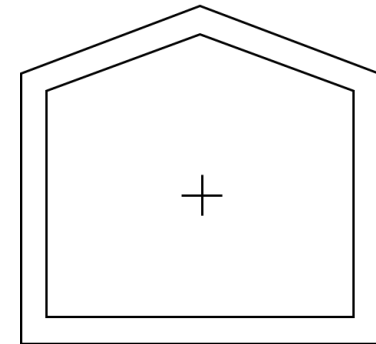

*Code 1.05: Cathedral*

## 2. Tilt & Turn – Inwards Opening Windows

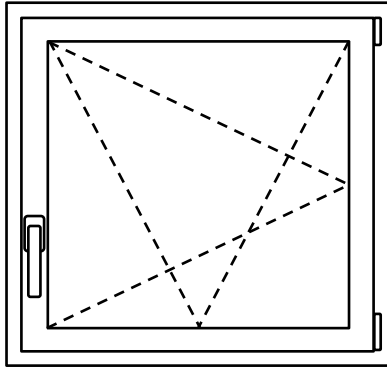

Code 2.01: Single Tilt & Turn

### KEYS

Outwards  
opening  
—

Inwards  
Opening  
- - - -

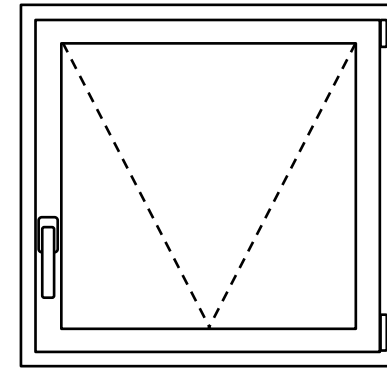
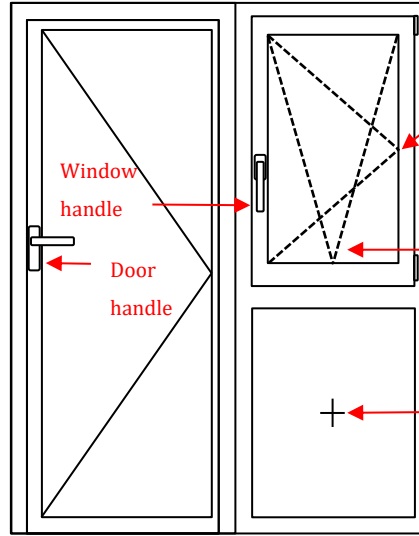

Code 2.02: Single Tilt Only

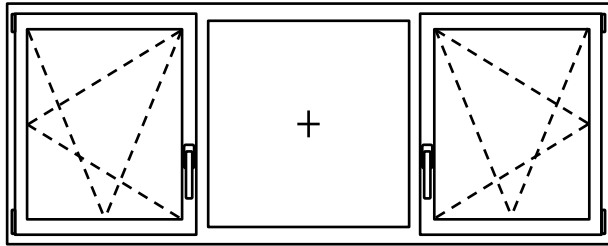

Code 2.03: 2 x Tilt & Turn, Fixed

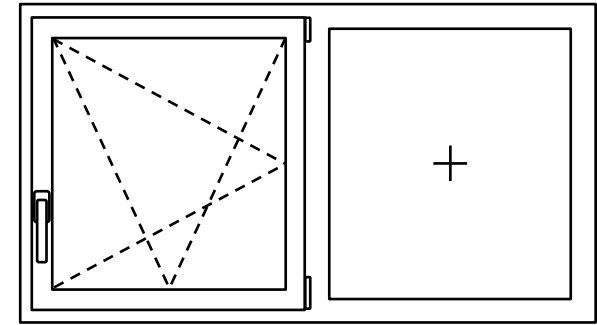

Code 2.04: Tilt & Turn, Fixed

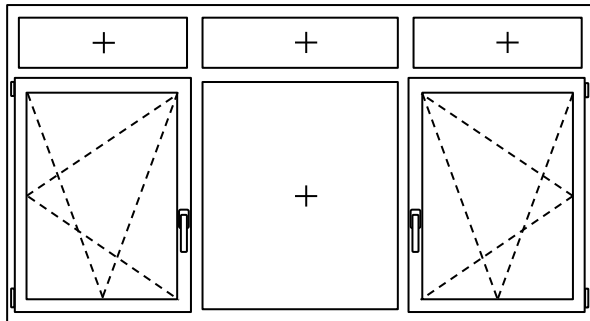

Code 2.05: 2 x Tilt & Turn, 4 x Fixed

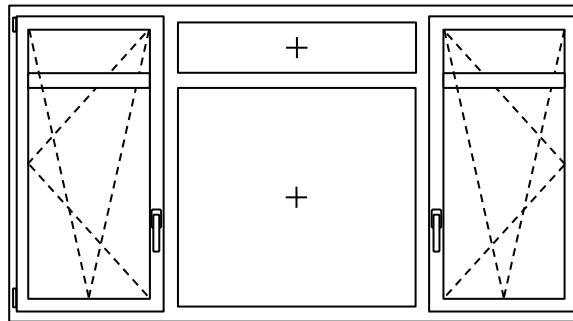

Code 2.06: 2 x Tilt & Turn, 2 x Fixed

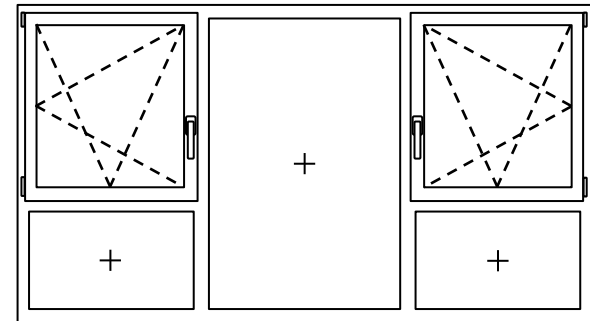

Code 2.07: 2 x Tilt & Turn, 3 x Fixed

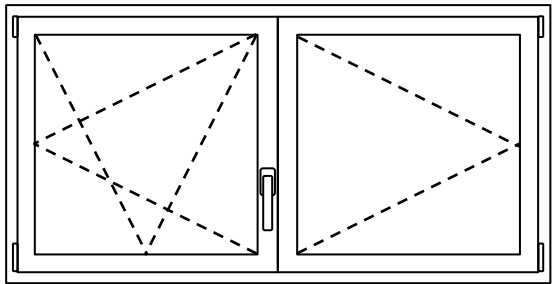

Code 2.08: Tilt & Turn, Turn. No mullion

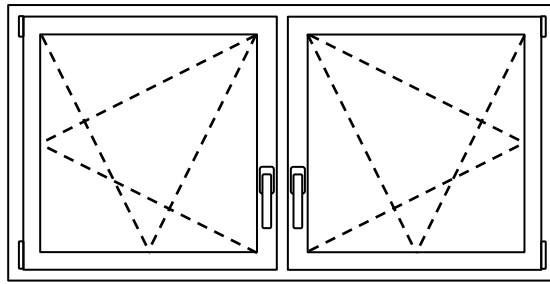

Code 2.09: 2 x Tilt & Turn, Mullion

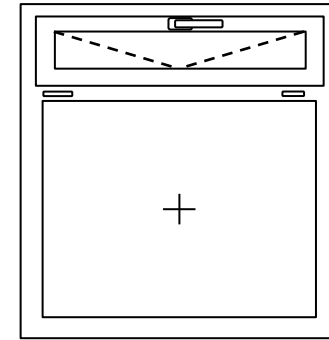

Code 2.10: Tilt Only, Fixed, Transom

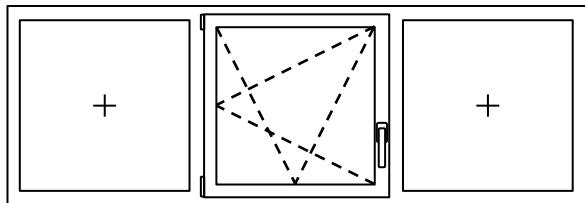

Code 2.11: Tilt & Turn, 2 x Fixed

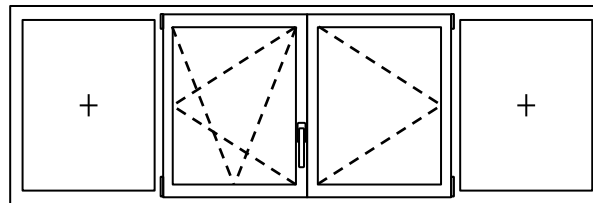

Code 2.12: Tilt & Turn/Turn, 2 x Fixed. No Mullion

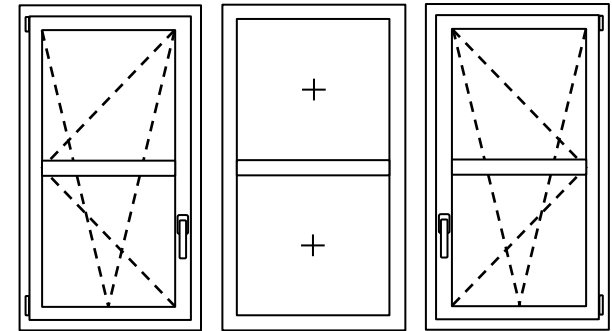

Code 2.13: 2 x Tilt & Turn Bay Window

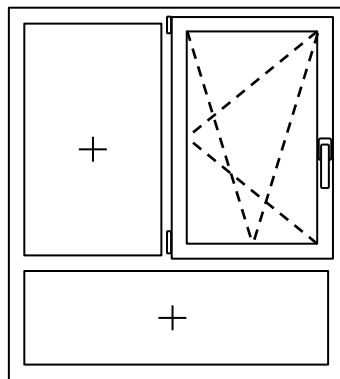

Code 2.14: Tilt & Turn Centre Hinge, 2 x Fixed

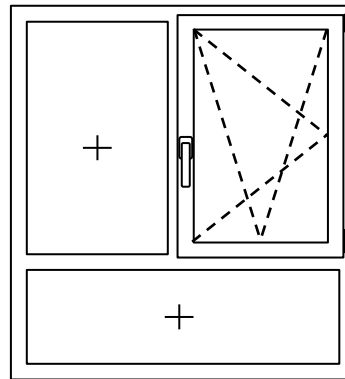

Code 2.15: Tilt & Turn, 2 x Fixed

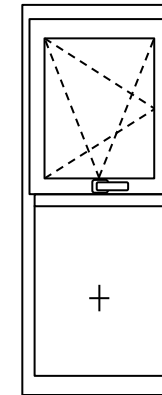

Code 2.16: Tilt & Turn, Fixed. Transom

### 3. Outwards Opening Windows

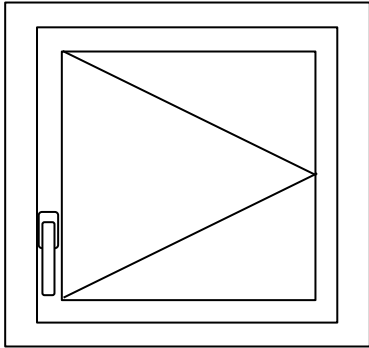

Code 3.01: Single Casement

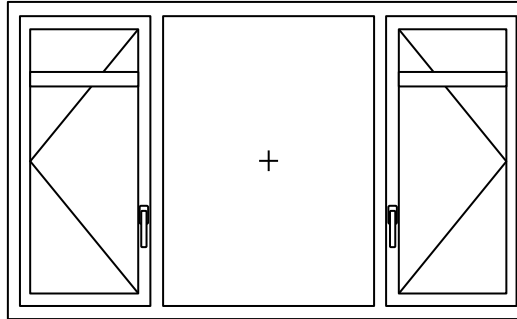

Code 3.02: 2 x Casement, Fixed

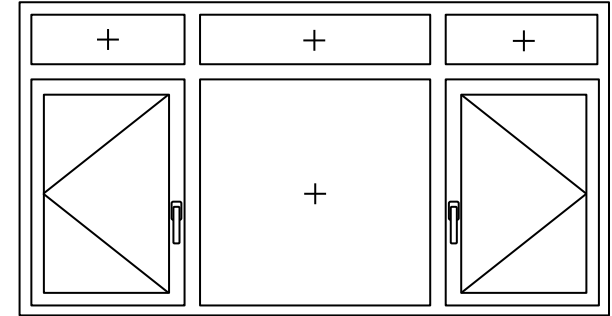

Code 3.03: 2 x Casement, 3 x Fixed

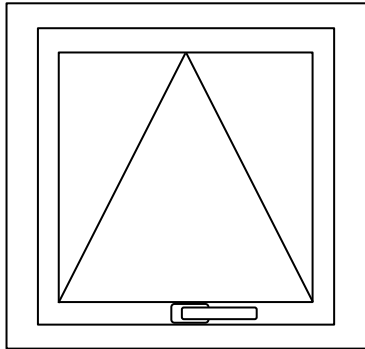

Code 3.04: Single Awning

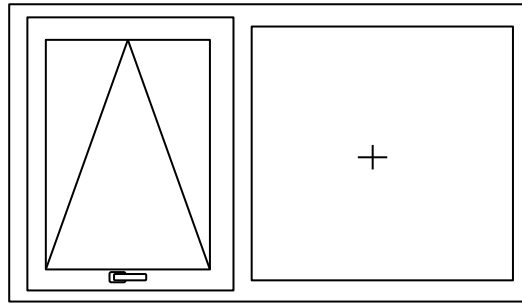

Code 3.05: Awning, Fixed

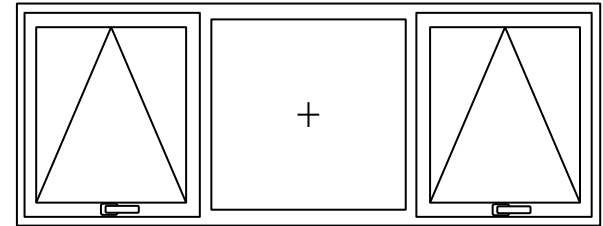

Code 3.06: 2 x Awning, Fixed

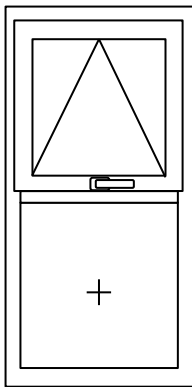

Code 3.07: Awning, Fixed. Transom

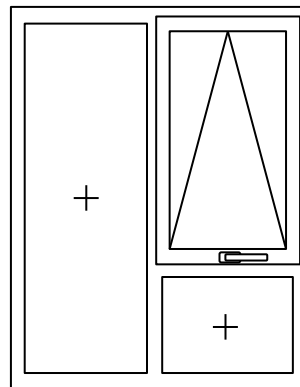

Code 3.08: Awning, 2 x Fixed

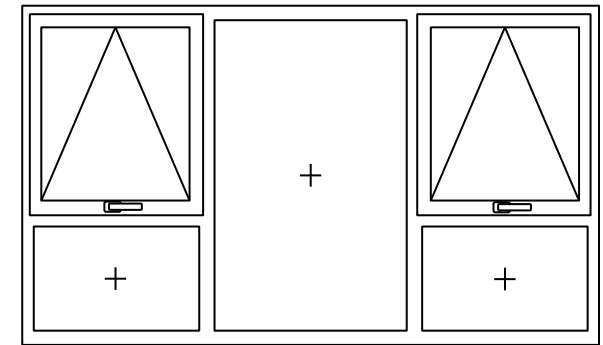

Code 3.09: 2 x Awning, 3 x Fixed

4. Sliding Windows and Doors – Stacking Slider / Multi Slider

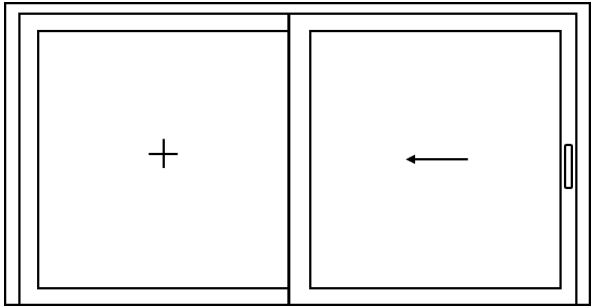

Code 4.01: 2 panel, fixed/sash

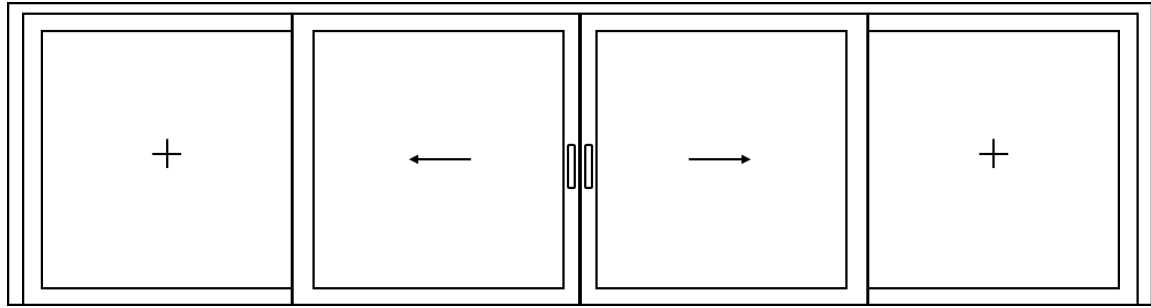

Code 4.02: 4 panel, fixed/2 x sashes/fixed

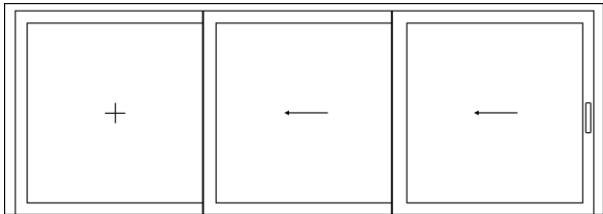

Code 4.03: 3 panel, fixed/2 x sashes

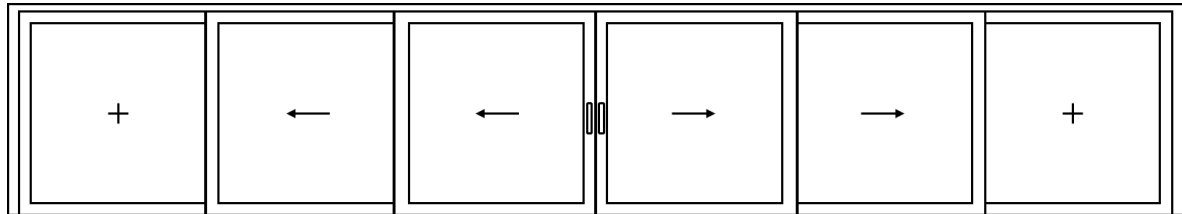

Code 4.04: 6 panel, fixed/4 x sashes/fixed

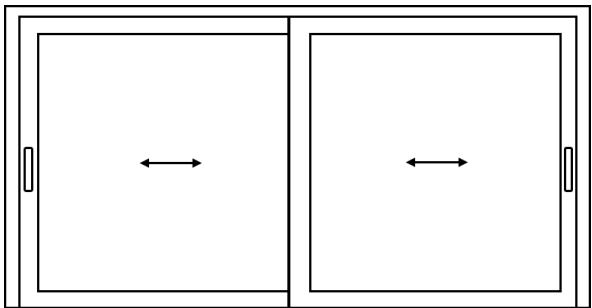

Code 4.05: 2 panel, 2 x sashes

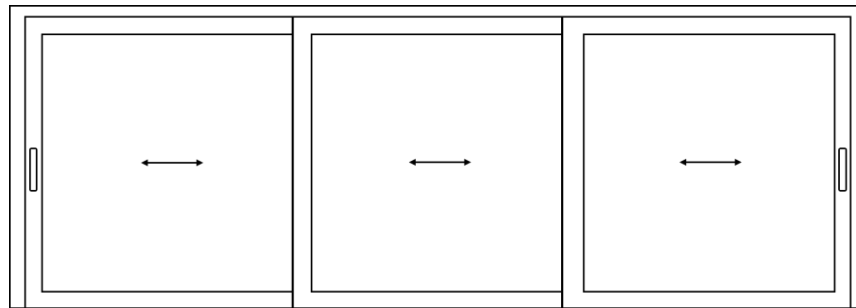

Code 4.06: 3 panel, 3 x sashes

**5. Bi-folding Windows and Doors – Inwards or Outwards Opening**

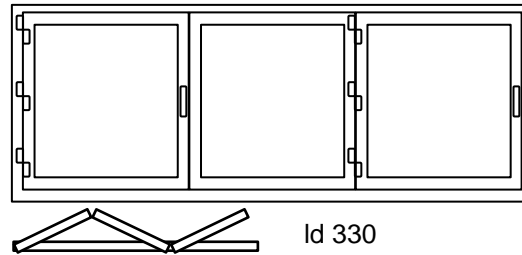
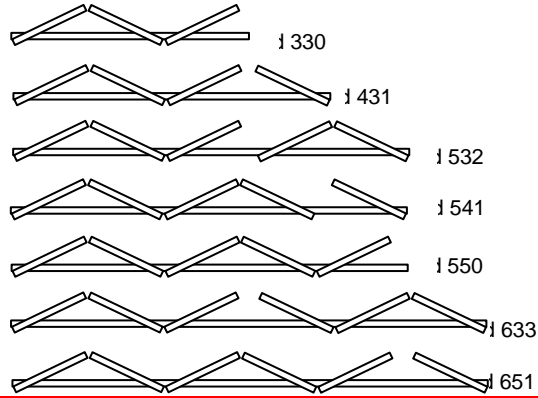

*Code 5.01: 330*

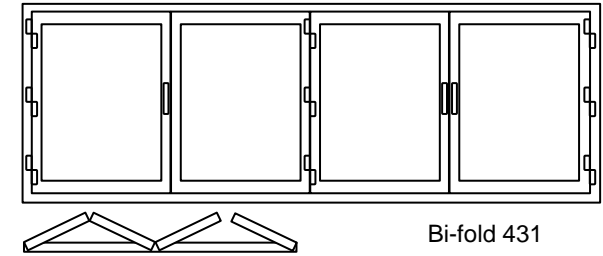

*Code 5.02: 431*

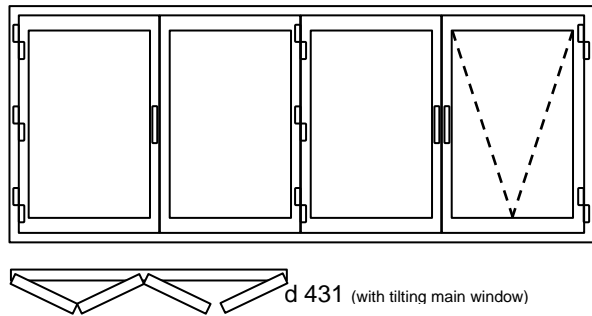

*Code 5.03: 431 inwards*

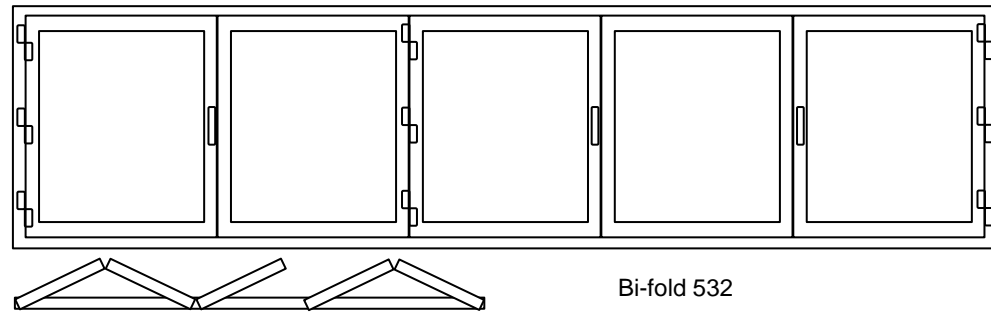

*Code 5.04: 532*

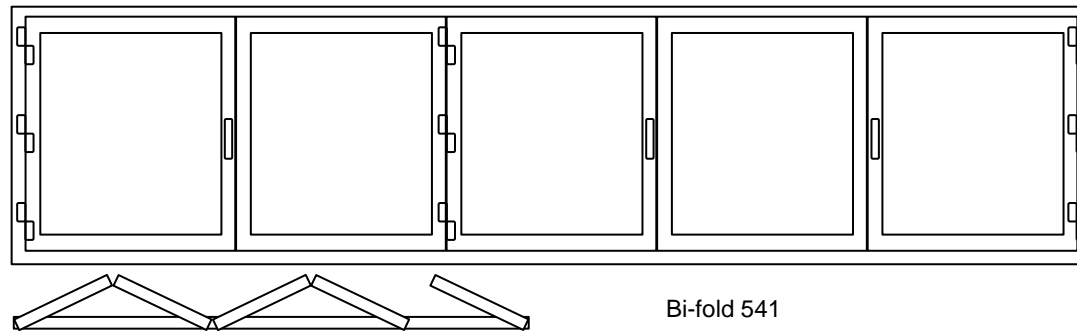

*Code 5.05: 541*



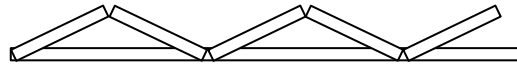
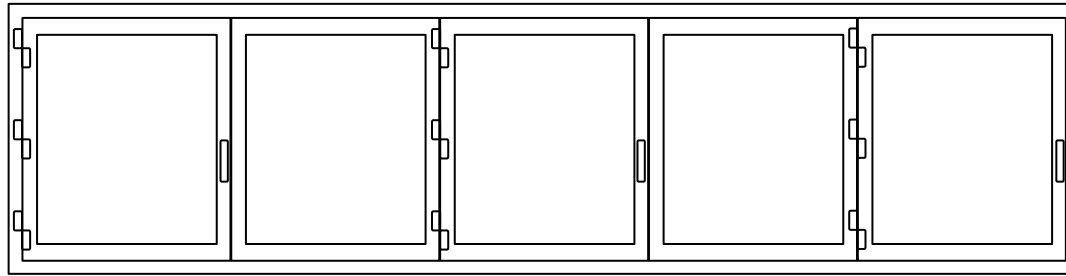

Bi-fold 550

*Code 5.06: 550*

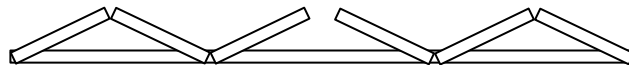
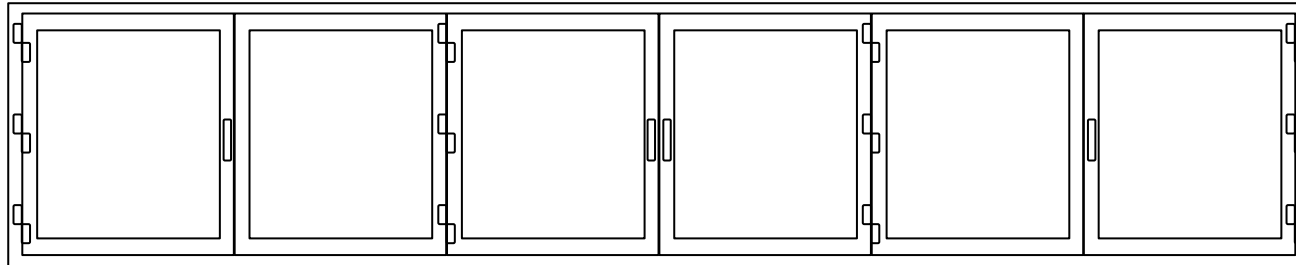

Bi-fold 633

*Code 5.07: 633*

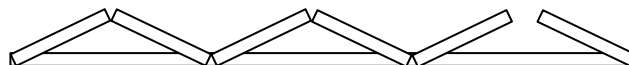
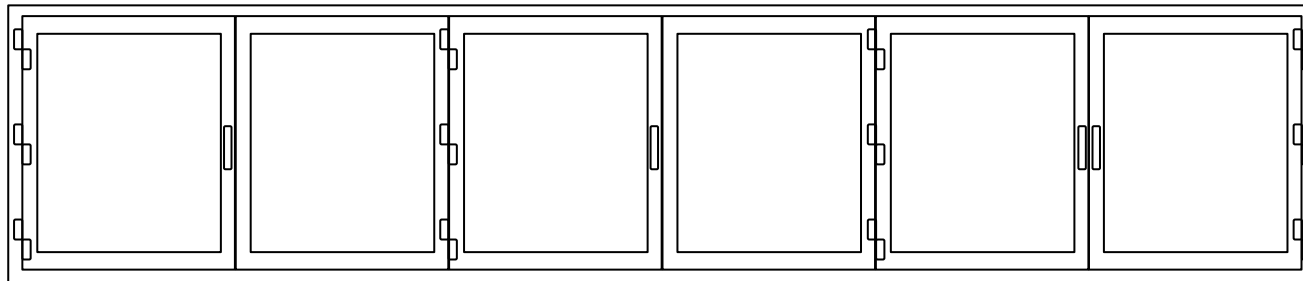

Bi-fold 651

*Code 5.08: 651*

## 6. Entrance Doors

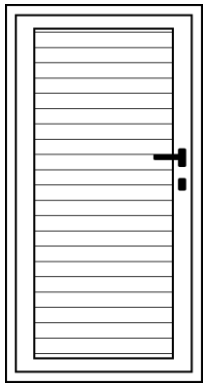

Code 6.01: Horizontal T&G

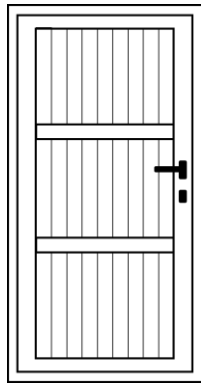

Code 6.02: 3 x Vertical T&G

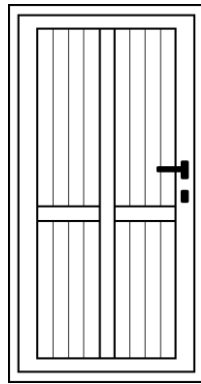

Code 6.03: 4 x Vertical T&G

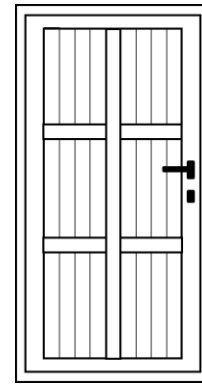

Code 6.04: 6 x Vertical T&G

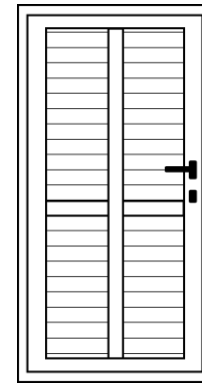

Code 6.05: 4 x Horizontal T&G

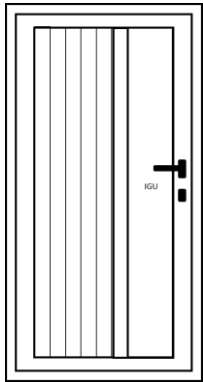

Code 6.06: Vertical T&G, Glass

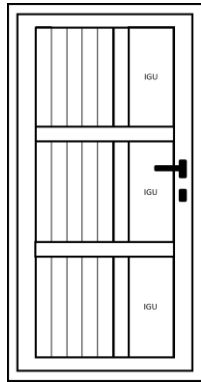

Code 6.07: 3 x Vert. T&G/Glass

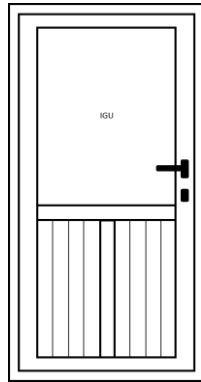

Code 6.08: 2 x Vert. T&G, Glass

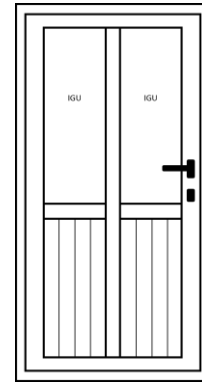

Code 6.09: 2 x Vert. T&G/Glass

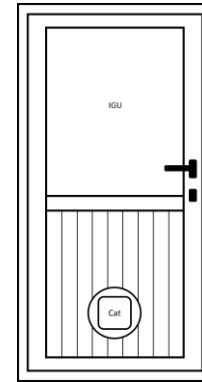

Code 6.10: Vert. T&G, Glass, PD

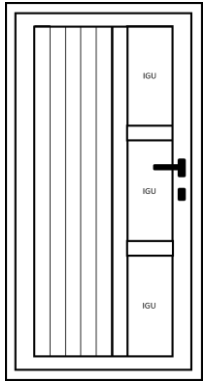

Code 6.11: Vert. T&G, 3 x Glass

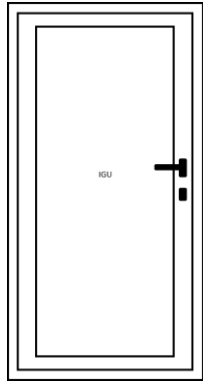

Code 6.12: Glass

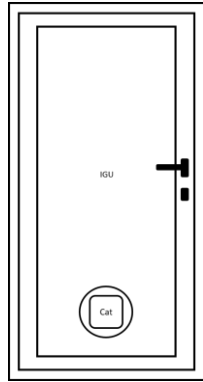

Code 6.13: Glass, PD

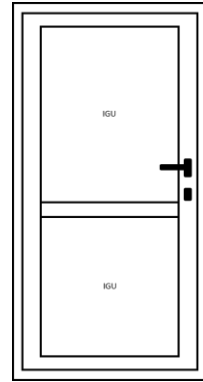

Code 6.14: 2 x Glass

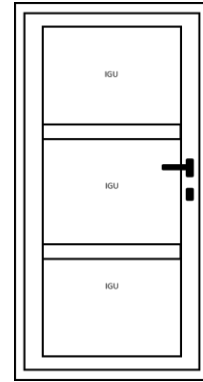

Code 6.15: 3 x Glass

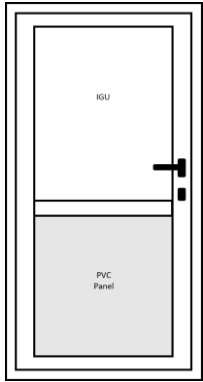

Code 6.16: Panel, Glass H

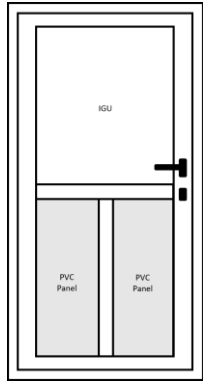

Code 6.17: 2 x Panel, Glass

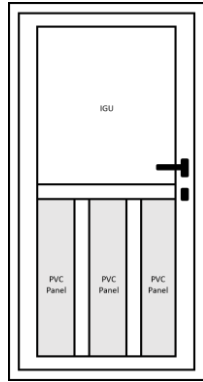

Code 6.18: 3 x Panel, Glass

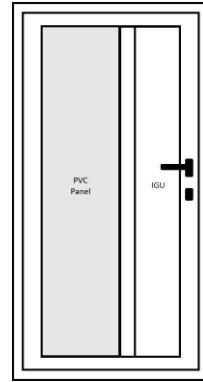

Code 6.19: Panel, Glass V

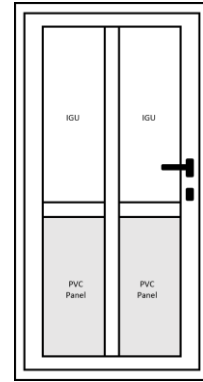

Code 6.20: 2 x Panel, 2 x Glass

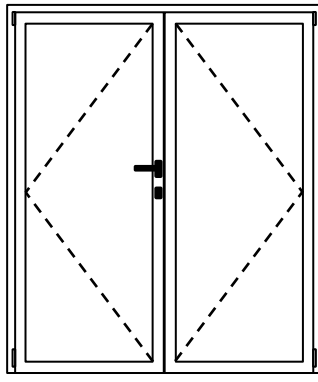

Code 6.21: French, Glass

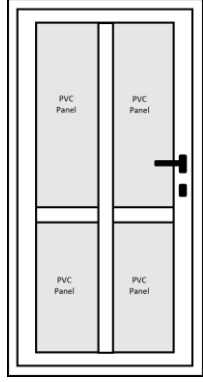

Code 6.22: 4 x Panel

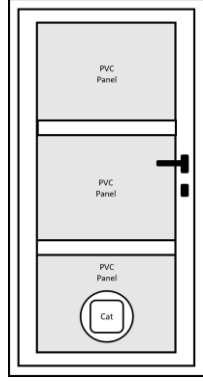

Code 6.23: 3 x Panel, PD

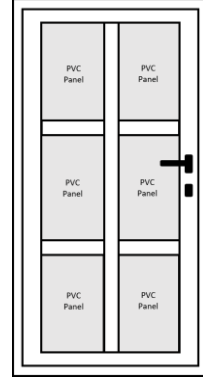

Code 6.24: 6 x Panel

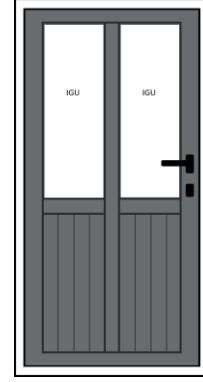

Code 6.25: 2 x Vert. T&G/Glass

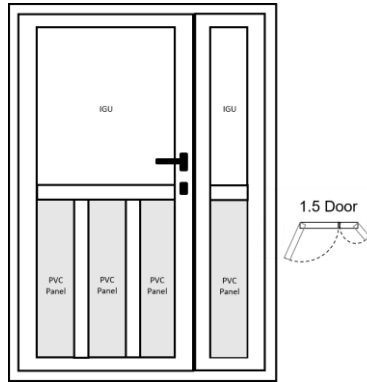

Code 6.26: 1.5 4 x Panel, 3 x Glass

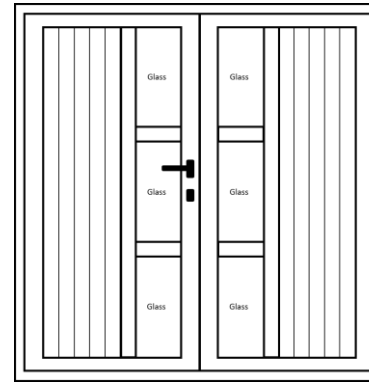

Code 6.27: French, 2 x Vert. T&G, 6 x Glass

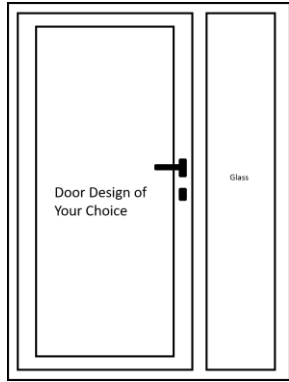

Code 6.28: Door/Sidelight

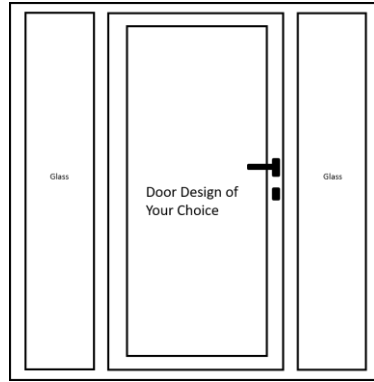

Code 6.29: Door/2 x Sidelight

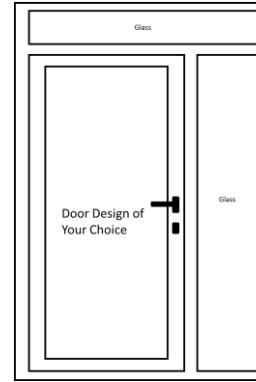

Code 6.30: Door/Sidelight/Top light

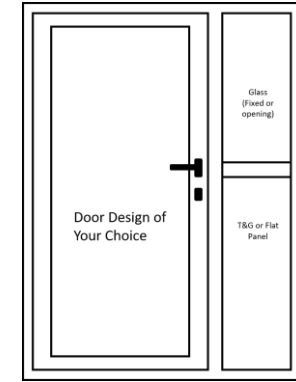

Code 6.31: Door/Sidelight (transom)

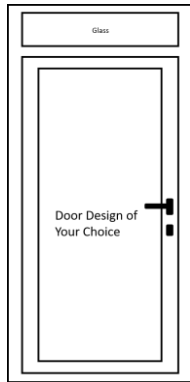

Code 6.32: Door/Top light

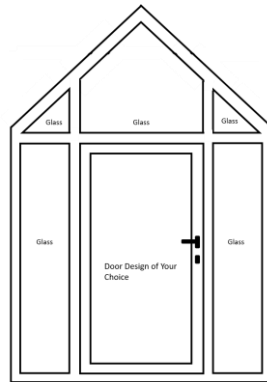

Code 6.33: Door/2 x Sidelight/Cathedral Top light

Please speak to us about your design requirements.

**7. Single and French Doors (inwards and outwards opening)**

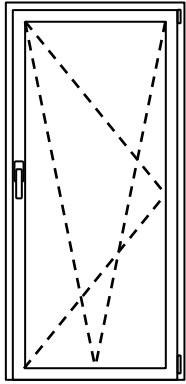

Code 7.01: IW Tilt & Turn

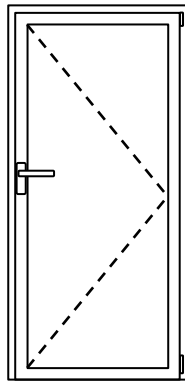

Code 7.02: IW Turn

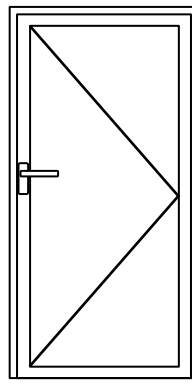

Code 7.03: OW Turn

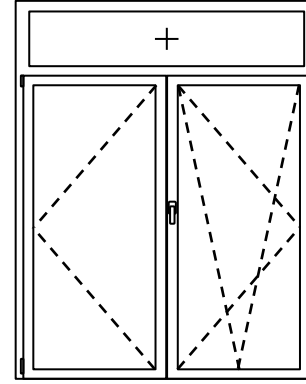

Code 7.04: IW French T&T, TL

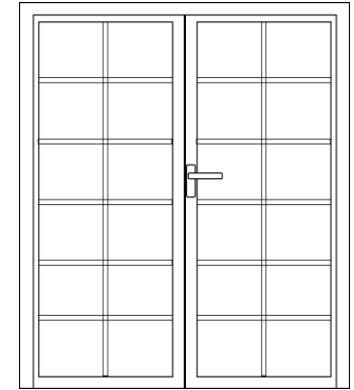

Code 7.05: French Colonial

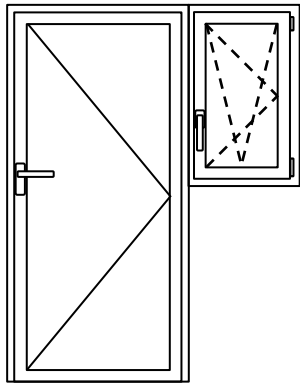

Code 7.06: OW Door, IW T&T

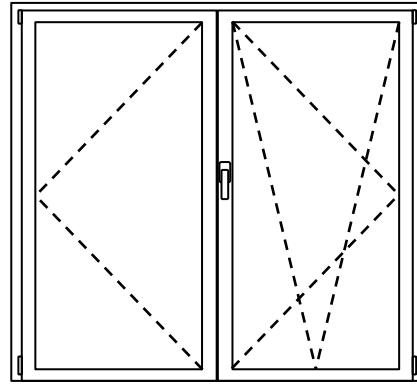

Code 7.07: IW French Tilt & Turn

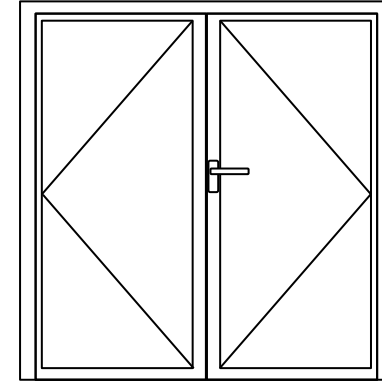

Code 7.08: OW French

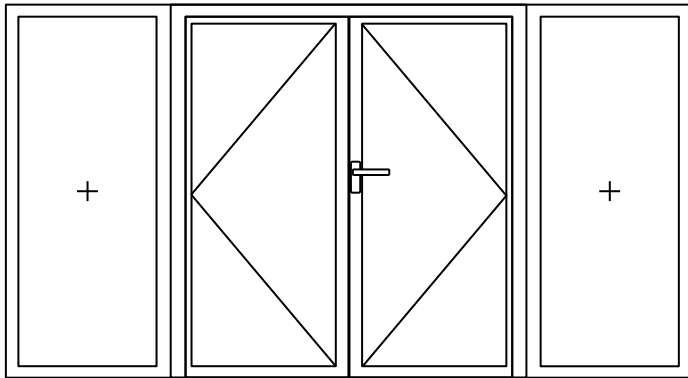

Code 7.09: OW French, 2 x Sidelights

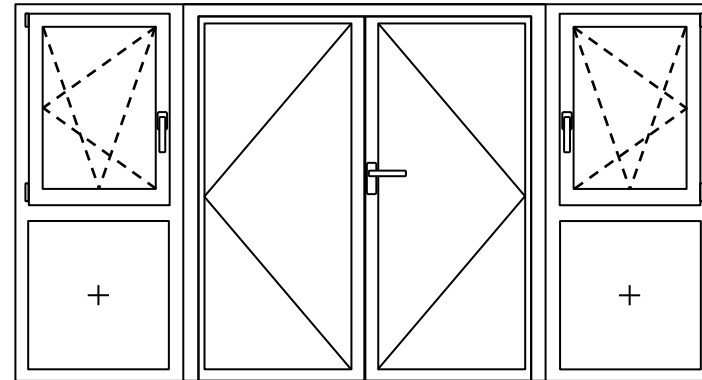

Code 7.10: OW French, 2 x Tilt & Turn Sidelights with Transoms

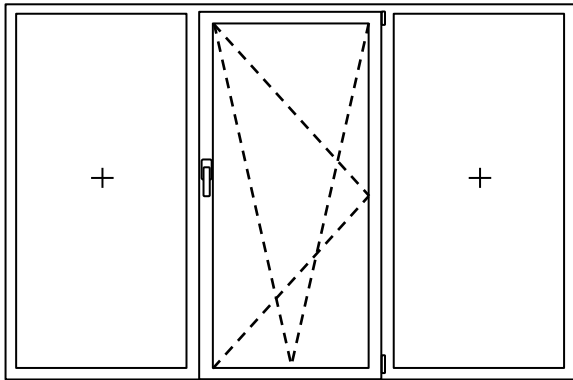

Code 7.11: IW Door, 2 x Sidelights

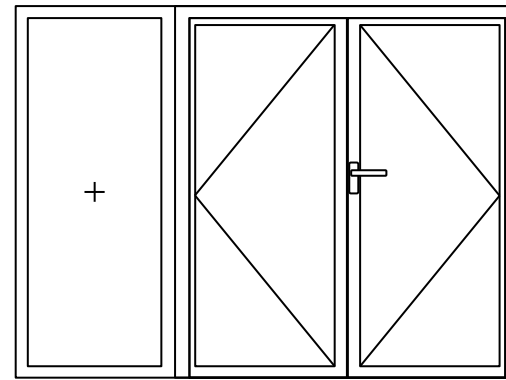

Code 7.12: OW French, Sidelight

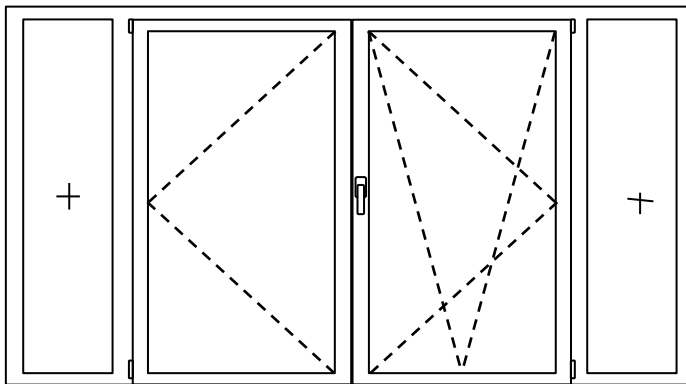

Code 7.13: IW French, 2 x Sidelights

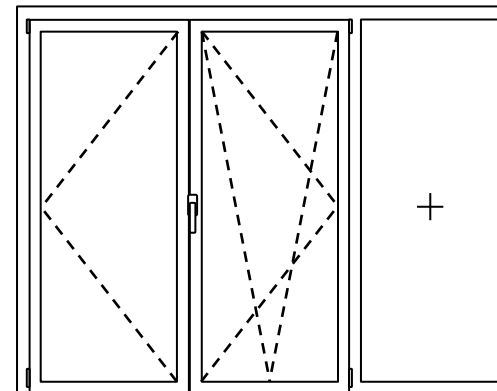

Code 7.14: IW French, Sidelight

8. Sliding Doors – Tilt & Slide

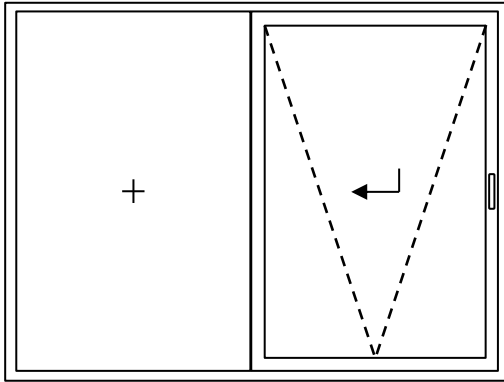

Code 8.01: 2 panel, fixed/sash

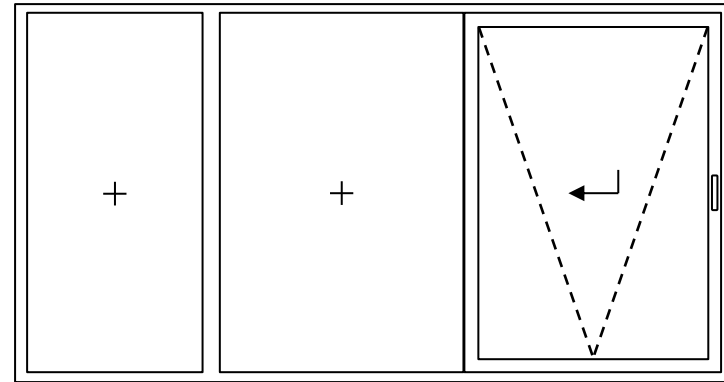

Code 8.02: 3 panel, fixed/fixed/sash

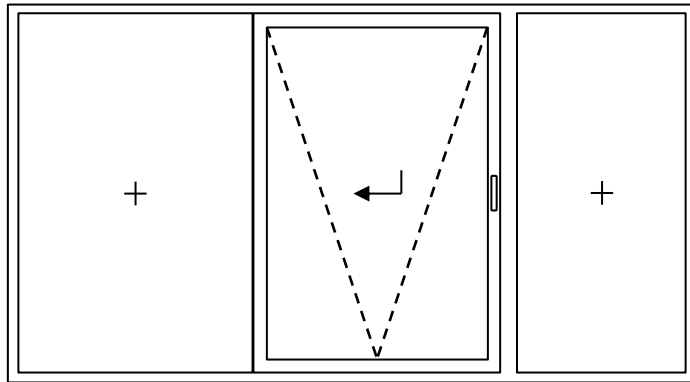

Code 8.03: 3 panel, fixed/sash/fixed

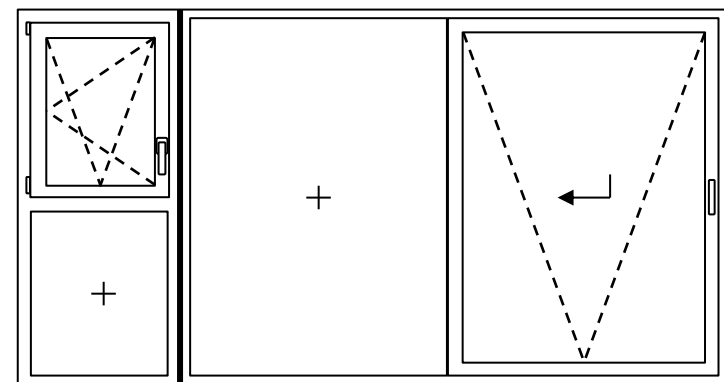

Code 8.04: IW window, 2 panel, fixed/sash

**9. Sliding Doors – Smart Slider**

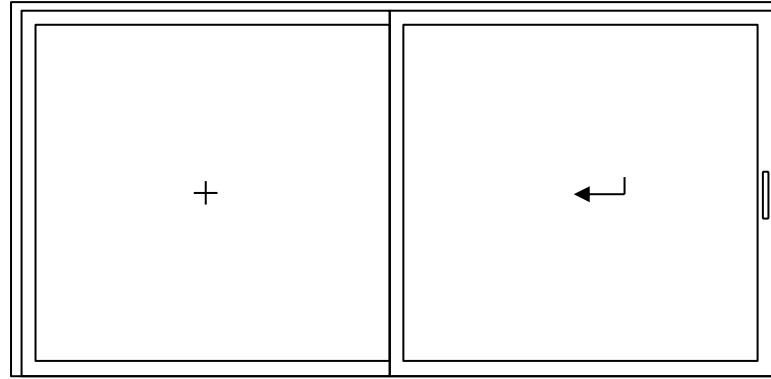

*Code 9.01: 2 panel, fixed, sash*

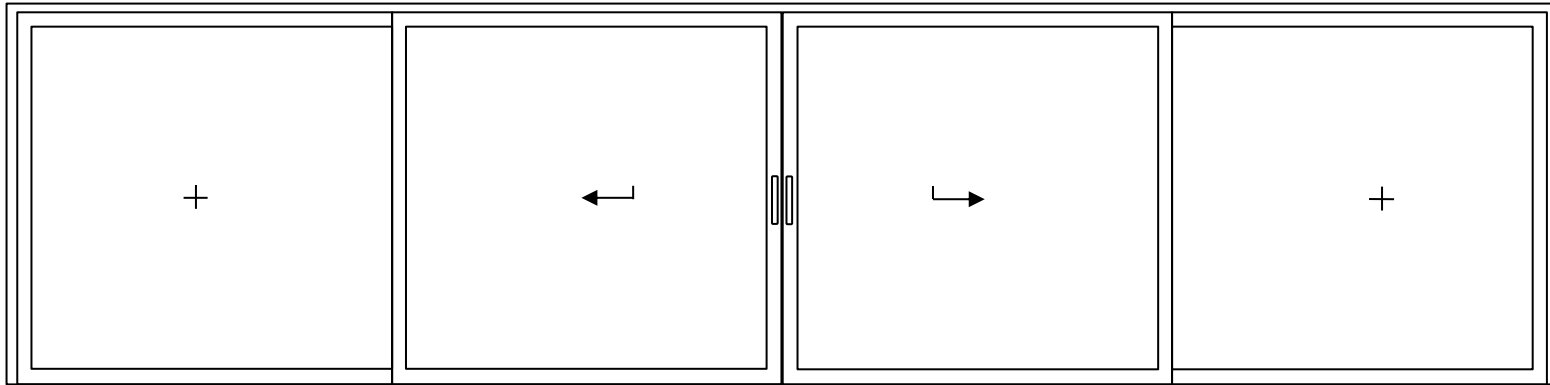

*Code 9.02: 4 panel, fixed/2 x sashes/fixed*



**10. Sliding Doors – Lift & Slide**

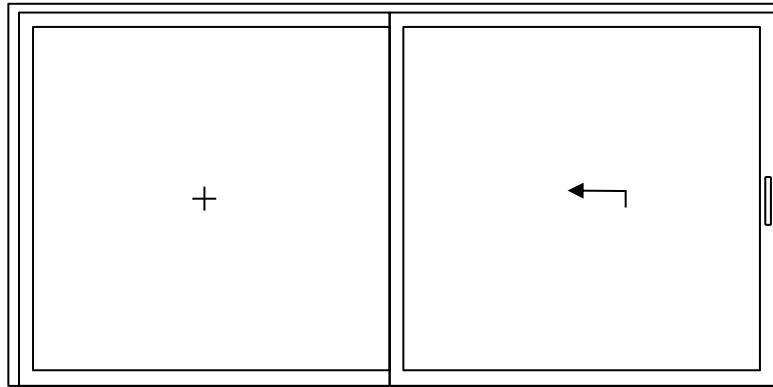

*Code 10.01: 3 panel, sash, 2 x fixed*

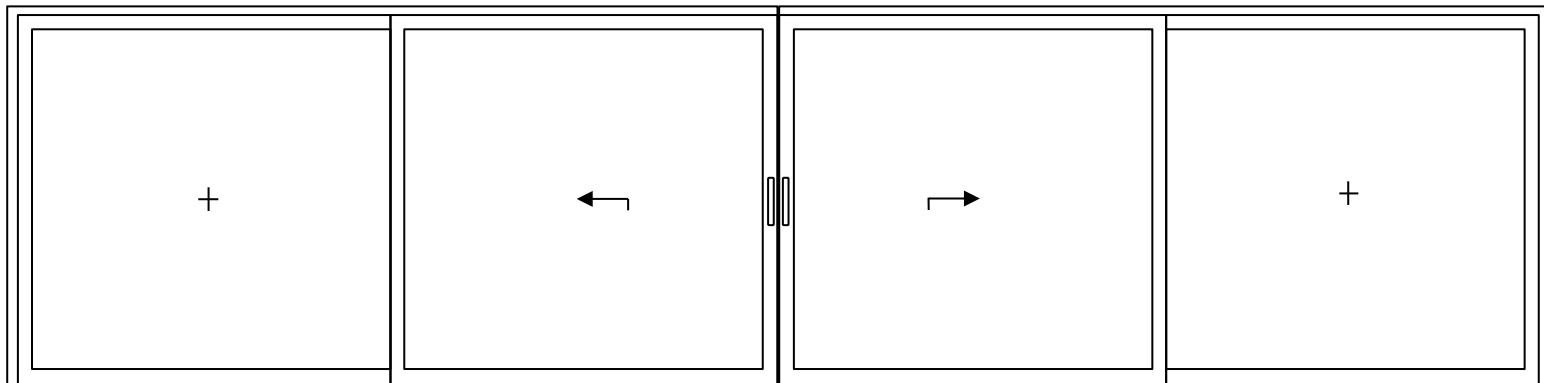

*Code 10.02: 4 panel, fixed/2 x sashes/fixed*